

DRAINING TILE AND ACCESSORIES

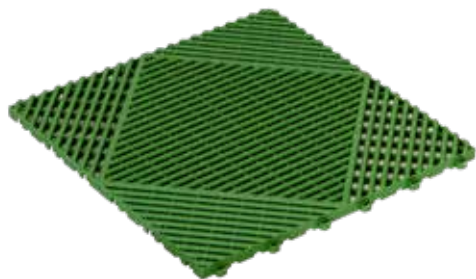

INDEX

1. Code Registry
2. Description
3. Use
4. Accessories
5. Technical specification

1. CODE REGISTRY

Code	Description	Dimension (mm)	Weight	Pkg. / Pallet
GAR01-0015R	Red draining tile	400 x 400 - h. 18	0,50 kg/pz.	6 pz. / 324 pz.
GAR01-0015V	Green draining tile	400 x 400 - h. 18	0,50 kg/pz.	6 pz. / 324 pz.
GAR01-0015GC	Grey draining tile	400 x 400 - h. 18	0,50 kg/pz.	6 pz. / 324 pz.
GAR01-0030R	Ramp with "female" hooking for draining tile - Red	400 x 60 h. 18	0,069	25 pz. / 1.575 pz
GAR01-0030V	Ramp with "female" hooking for draining tile - Green	400 x 60 h. 18	0,069	25 pz. / 1.575 pz
GAR01-0030GC	Ramp with "female" hooking for draining tile - Grey	400 x 60 h. 18	0,069	25 pz. / 1.575 pz
GAR01-0031R	Ramp with "male" hooking for draining tile - Red	400 x 60 h. 18	0,067	25 pz. / 1.575 pz
GAR01-0031V	Ramp with "male" hooking for draining tile - Green	400 x 60 h. 18	0,067	25 pz. / 1.575 pz
GAR01-0031GC	Ramp with "male" hooking for draining tile - Grey	400 x 60 h. 18	0,067	25 pz. / 1.575 pz
GAR01-0032R	Corner with "female" hooking for draining tile - Red - Red	60 x 60 h. 18	0,004	100 pz. / 14.400
GAR01-0032V	Corner with "female" hooking for draining tile - Red - Green	60 x 60 h. 18	0,004	100 pz. / 14.400
GAR01-0032GC	Corner with "female" hooking for draining tile - Red - Grey	60 x 60 h. 18	0,004	100 pz. / 14.400
GAR01-0033R	Corner with "female-female" hooking for draining tile - Red	60x60 h18	0,005	100 pz. / 14.400
GAR01-0033V	Corner with "female-female" hooking for draining tile - Green	60x60 h18	0,005	100 pz. / 14.400
GAR01-0033GC	Corner with "female-female" hooking for draining tile - Grey	60x60 h18	0,005	100 pz. / 14.400

MATERIAL Made of PP (polypropylene).

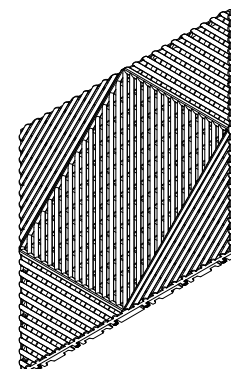
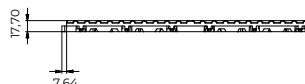
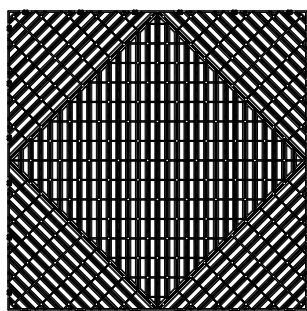
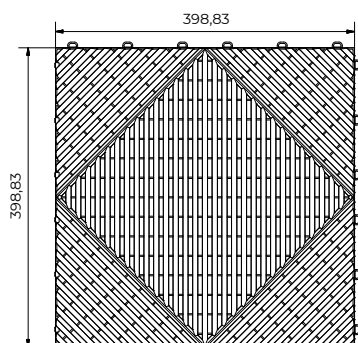

DRAINING TILE AND ACCESSORIES

2. DESCRIPTION

Draining garden tile in PP, green, red and gray color. Modular interlocking elements, measures 400 x 400 x 18 mm. Its accessories allow the perfectly functional laying of draining tiles and realize the aesthetic completeness.

3. USE

For alternative uses both indoor and outdoor.
For terraces, winter gardens and wellness centers areas.
For grassy or screed surfaces intended for garden furniture, recreational activities and/or walkways.

4. ACCESSORIES

These accessories are the perfect integration of the drainage tile in order to guarantee a perfect lateral finishing. The ramps and the corners have a modular interlocking system that is divided in 2 different type/each:

- Ramp with "female" interlocking system
- Ramp with "male" interlocking system
- Corner for with "female" interlocking system
- Corner for with "female-female" interlocking system

Ramps are sold in bags of 10 pieces/each

Both ramps and corners are made of PP (polypropylene).

Ramps and corners can be matched together and the very easy looking system guarantee a quick positioning and use. These products are perfect where there is a need to create a stable and removable outdoor flooring, to be used in residential areas or garden intended for garden furniture and/or recreational activities and/or walkways.

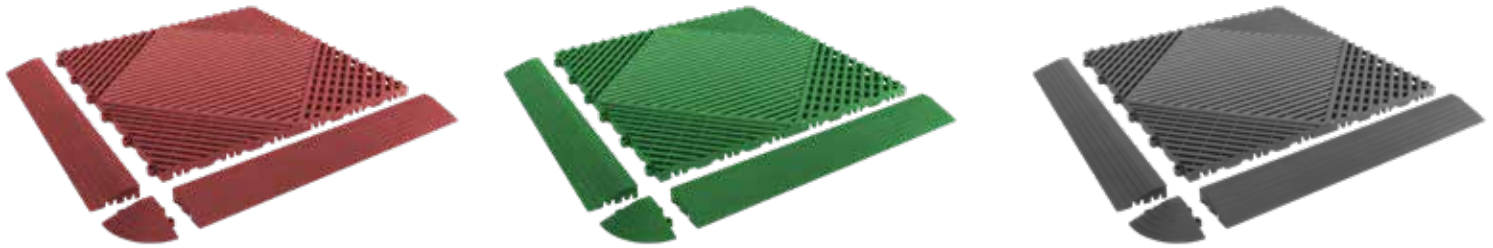

01 Ramp with "female" hooking



02 Ramp with "male" hooking



03 Corner with "female" hooking



04 Corner with "female-female" hooking

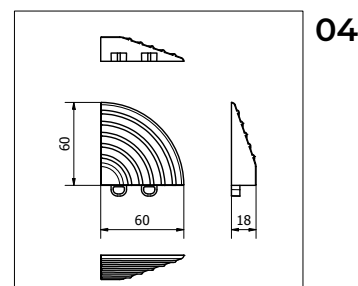
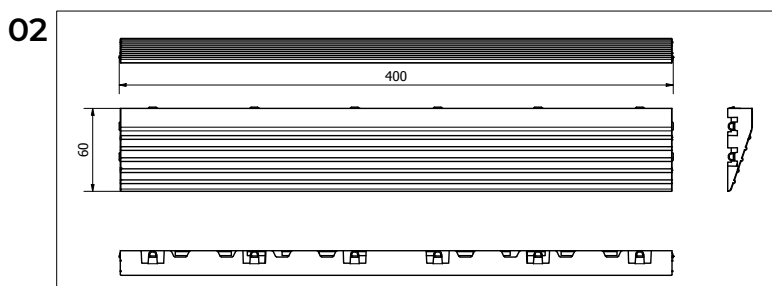
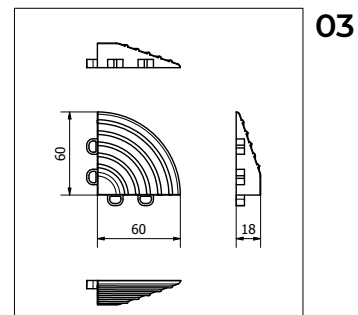
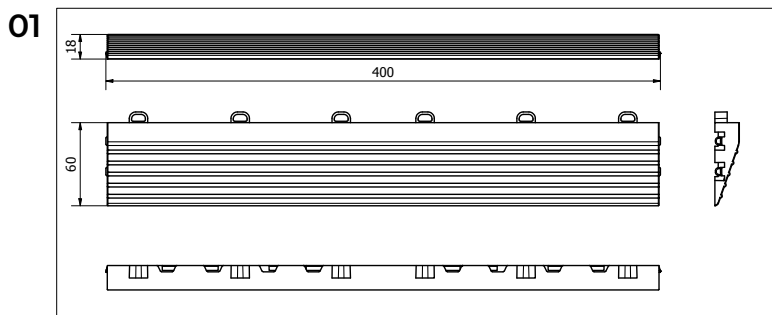

DRAINING TILE AND ACCESSORIES

5. VOCI DI CAPITOLATO

Voce	Descrizione	Unità	Prezzo
Dak.O.GAR01.0015x	Supply and installation of draining tile and its accessories for Garden in PP, available in green, grey and red colour. Element modular interlocking measures 400 x 400 x 18 mm. Made of PP (polypropylene). Alternative uses for residential lawns or garden furniture intended for screed and/or recreational activities and/or walkways. Dimension 400 x 400 height 18 mm		
Dak.O.GAR01.0015R	Red draining tile.....	pz.	-
Dak.O.GAR01.0015V	Green draining tile.....	pz.	-
Dak.O.GAR01.0015GC	Grey draining tile.....	pz.	-
DAK.O.GAR01-0030R	Ramp with "female" hooking for draining tile - Red.....	pz.	-
DAK.O. GAR01-0030V	Ramp with "female" hooking for draining tile - Green.....	pz.	-
DAK.O. GAR01-0030GC	Ramp with "female" hooking for draining tile - Grey.....	pz.	-
DAK.O. GAR01-0031R	Ramp with "male" hooking for draining tile - Red.....	pz.	-
DAK.O. GAR01-0031V	Ramp with "male" hooking for draining tile - Green.....	pz.	-
DAK.O. GAR01-0031GC	Ramp with "male" hooking for draining tile - Grey.....	pz.	-
DAK.O. GAR01-0032R	Corner with "female" hooking for draining tile - Red.....	pz.	-
DAK.O. GAR01-0032V	Corner with "female" hooking for draining tile - Green.....	pz.	-
DAK.O. GAR01-0032GC	Corner with "female" hooking for draining tile - Grey.....	pz.	-
DAK.O. GAR01-0033R	Corner with "female-female" hooking for draining tile - Red.....	pz.	-
DAK.O. GAR01-0033V	Corner with "female-female" hooking for draining tile - Green.....	pz.	-
DAK.O. GAR01-0033GC	Corner with "female-female" hooking for draining tile - Grey.....	pz.	-