

PEGASUS SHORT CHANNEL 200 x 165

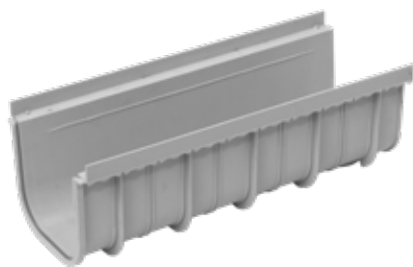

INDEX

1. Code Registry
2. Use
3. Technical Specification

1. CODE REGISTRY

Code	Description	Dimensions (mm)	Weight	Colour	Pkg. / Pallet
POZ80-1364	Pegasus Short 200/165	200 x 165 x 500	0,863 kg/pc.	Grey	12 pcs / 96 pcs

MATERIAL Made of PP (polypropylene).

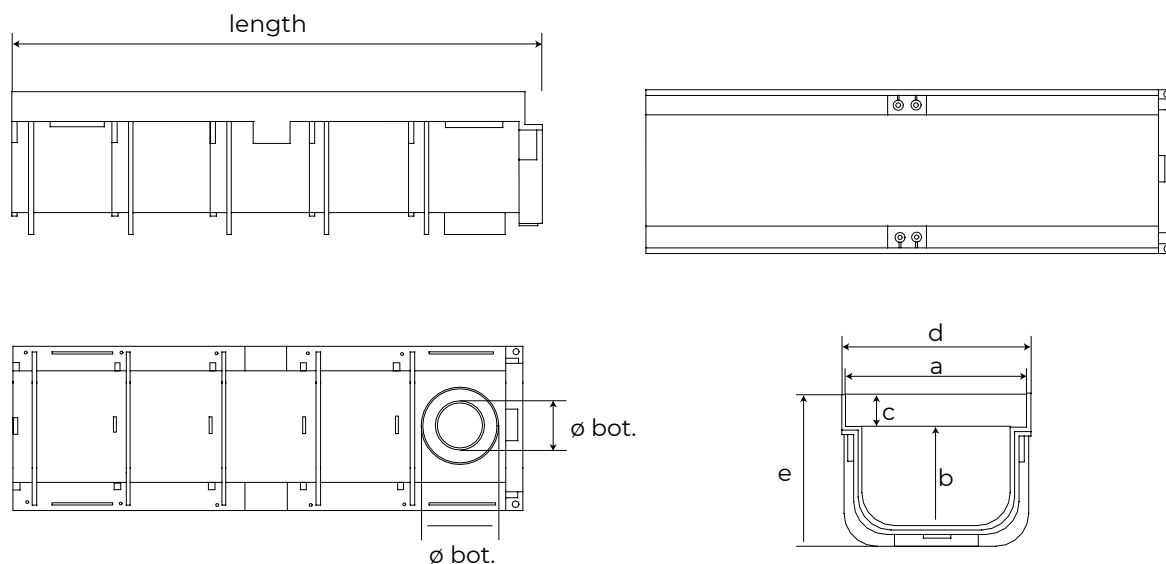

exemplifying image

	a	b	c	d	e	length	ø lat.	ø bot.
POZ80-1364	195	137	21	200	172	507	-	63/75 mm

PEGASUS SHORT CHANNEL 200 x 165

2. USE

Used for the collection and drainage of rainwater.
The matching to its range of gratings allows the use in pedestrian or light traffic areas.

3. TECHNICAL SPECIFICATION

Specification	Description	Unity	Price
Dak.D.POZ80.1364	Supply and installation of drainage Channel for collection of meteoric waters. Engineered and reinforced for a high resistance. Available in grey colour. External bottom outlet are \varnothing 63/75 mm. Made of PP (polypropylene). Used for the collection and drainage of rainwater. The matching to its range of gratings allows the use in pedestrian or light traffic areas.	pc.	-