

# DRAINING TILE AND ACCESSORIES

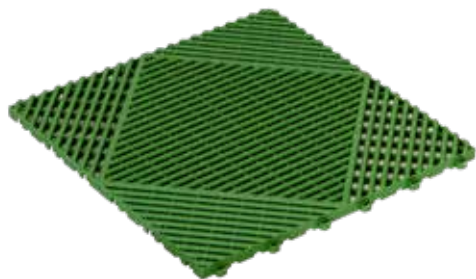

## INDEX

1. Code Registry
2. Description
3. Use
4. Accessories
5. Technical specification

## 1. CODE REGISTRY

Code	Description	Dimension (mm)	Weight	Pkg. / Pallet
GAR01-0015R	Red draining tile	400 x 400 - h. 18	0,50 kg/pz.	6 pz. / 324 pz.
GAR01-0015V	Green draining tile	400 x 400 - h. 18	0,50 kg/pz.	6 pz. / 324 pz.
GAR01-0015GC	Grey draining tile	400 x 400 - h. 18	0,50 kg/pz.	6 pz. / 324 pz.
GAR01-0030R	Ramp with "female" hooking for draining tile - Red	400 x 60 h. 18	0,069	25 pz. / 1.575 pz
GAR01-0030V	Ramp with "female" hooking for draining tile - Green	400 x 60 h. 18	0,069	25 pz. / 1.575 pz
GAR01-0030GC	Ramp with "female" hooking for draining tile - Grey	400 x 60 h. 18	0,069	25 pz. / 1.575 pz
GAR01-0031R	Ramp with "male" hooking for draining tile - Red	400 x 60 h. 18	0,067	25 pz. / 1.575 pz
GAR01-0031V	Ramp with "male" hooking for draining tile - Green	400 x 60 h. 18	0,067	25 pz. / 1.575 pz
GAR01-0031GC	Ramp with "male" hooking for draining tile - Grey	400 x 60 h. 18	0,067	25 pz. / 1.575 pz
GAR01-0032R	Corner with "female" hooking for draining tile - Red - Red	60 x 60 h. 18	0,004	100 pz. / 14.400
GAR01-0032V	Corner with "female" hooking for draining tile - Red - Green	60 x 60 h. 18	0,004	100 pz. / 14.400
GAR01-0032GC	Corner with "female" hooking for draining tile - Red - Grey	60 x 60 h. 18	0,004	100 pz. / 14.400
GAR01-0033R	Corner with "female-female" hooking for draining tile - Red	60x60 h18	0,005	100 pz. / 14.400
GAR01-0033V	Corner with "female-female" hooking for draining tile - Green	60x60 h18	0,005	100 pz. / 14.400
GAR01-0033GC	Corner with "female-female" hooking for draining tile - Grey	60x60 h18	0,005	100 pz. / 14.400

**MATERIAL** Both ramps and corners are made of PP (polypropylene).

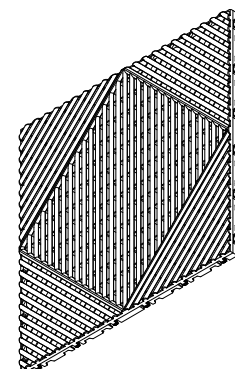
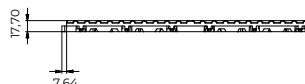
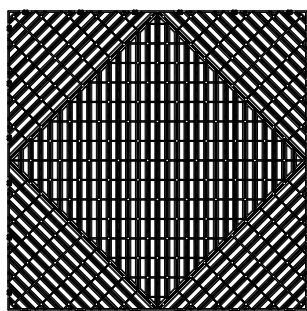
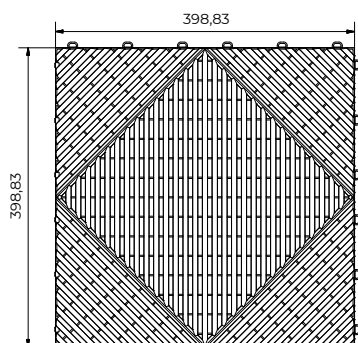

# DRAINING TILE AND ACCESSORIES

## 2. DESCRIPTION

Draining garden tile in PP, green, red and gray color. Modular interlocking elements, measures 400 x 400 x 18 mm. Its accessories allow the perfectly functional laying of draining tiles and realize the aesthetic completeness.

## 3. USE

Ramps and corners can be matched together and the very easy locking system guarantee a quick positioning and use. These products are perfect where there is a need to create a stable and removable outdoor flooring, to be used in residential areas or garden intended for garden furniture and/or recreational activities and/or walkways.

## 4. ACCESSORIES

These accessories are the perfect integration of the drainage tile in order to guarantee a perfect lateral finishing. The ramps and the corners have a modular interlocking system that is divided in 2 different type/each:

- Ramp with "female" interlocking system
- Ramp with "male" interlocking system
- Corner for with "female" interlocking system
- Corner for with "female-female" interlocking system

Ramps are sold in bags of 10 pieces/each

Both ramps and corners are made of PP (polypropylene). Ramps and corners can be matched together and the very easy locking system guarantee a quick positioning and use. These products are perfect where there is a need to create a stable and removable outdoor flooring, to be used in residential areas or garden intended for garden furniture and/or recreational activities and/or walkways.

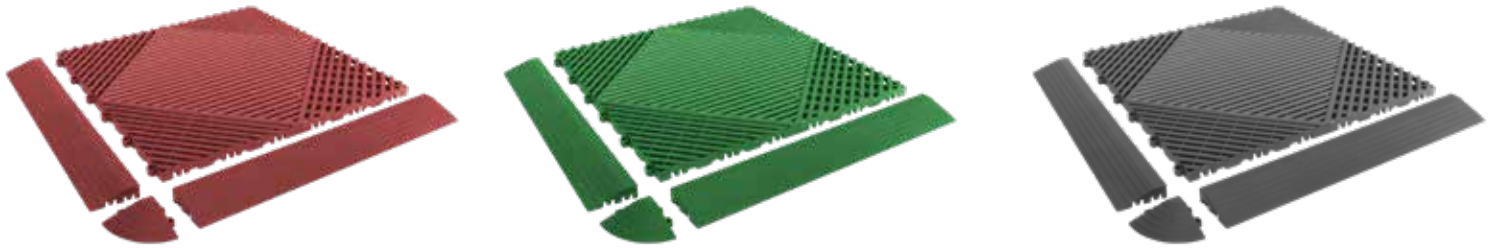

01 Ramp with "female" hooking



02 Ramp with "male" hooking



03 Corner with "female" hooking



04 Corner with "female-female" hooking

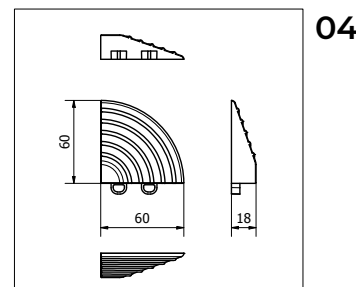
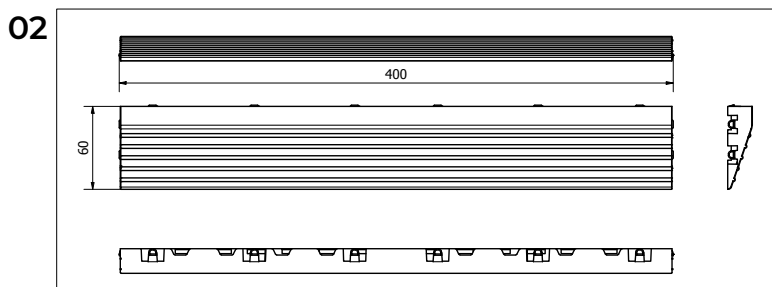
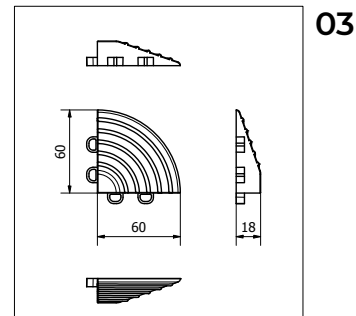
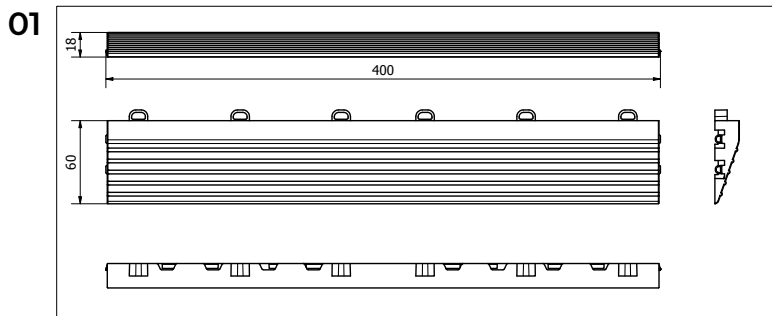

# DRAINING TILE AND ACCESSORIES

## 5. TECHNICAL SPECIFICATION

Specification	Description	Unity	Price
<b>Dak.O.GAR01.0015x</b>	Supply and installation of draining tile and its accessories for Garden in PP, available in green, grey and red colour. Element modular interlocking measures 400 x 400 x 18 mm. Made of PP (polypropylene). Alternative uses for residential lawns or garden furniture intended for screed and/or recreational activities and/or walkways. Dimension 400 x 400 height 18 mm		
<b>Dak.O.GAR01.0015R</b>	Red draining tile.....	pz.	-
<b>Dak.O.GAR01.0015V</b>	Green draining tile.....	pz.	-
<b>Dak.O.GAR01.0015GC</b>	Grey draining tile.....	pz.	-
<b>DAK.O.GAR01-0030R</b>	Ramp with "female" hooking for draining tile - Red.....	pz.	-
<b>DAK.O. GAR01-0030V</b>	Ramp with "female" hooking for draining tile - Green.....	pz.	-
<b>DAK.O. GAR01-0030GC</b>	Ramp with "female" hooking for draining tile - Grey.....	pz.	-
<b>DAK.O. GAR01-0031R</b>	Ramp with "male" hooking for draining tile - Red.....	pz.	-
<b>DAK.O. GAR01-0031V</b>	Ramp with "male" hooking for draining tile - Green.....	pz.	-
<b>DAK.O. GAR01-0031GC</b>	Ramp with "male" hooking for draining tile - Grey.....	pz.	-
<b>DAK.O. GAR01-0032R</b>	Corner with "female" hooking for draining tile - Red.....	pz.	-
<b>DAK.O. GAR01-0032V</b>	Corner with "female" hooking for draining tile - Green.....	pz.	-
<b>DAK.O. GAR01-0032GC</b>	Corner with "female" hooking for draining tile - Grey.....	pz.	-
<b>DAK.O. GAR01-0033R</b>	Corner with "female-female" hooking for draining tile - Red.....	pz.	-
<b>DAK.O. GAR01-0033V</b>	Corner with "female-female" hooking for draining tile - Green.....	pz.	-
<b>DAK.O. GAR01-0033GC</b>	Corner with "female-female" hooking for draining tile - Grey.....	pz.	-